



The V320i thermal transfer printer

Industry-leading speeds, versatility and economy



The highest performing and most cost effective coding solution for flexibles and labels.



Scan the code to find out more about V-Series

Domino. Do more.

A quick tour around the V320i

Optional wall mounted **TouchPanel**, certified to IP65 standards – Alternatively use any PC based interface

QuickStep graphical user interface for effortless control and status reporting



Continuous and Intermittent Mode functionality in one printer – suitable for all applications

Proven 'Dancing Arm' technology allows printing at the fastest line speeds, ensuring no ribbon break related downtime

1600m ribbon rolls for the longest production runs without replacement

i-Tech Ribbon Drive reduces ribbon use by up to 60% without compromising code quality

Two print head width options (53mm and 128mm) offer wide range of print areas at 300dpi

Our next generation of primary coders deploy our unique *intelligent Technology* system, **i-Tech**. Our aim was to make production lines lower maintenance, lower cost and more efficient. **i-Tech** has helped us to achieve that aim.

Domino. Do more.

The ultimate in Thermal Transfer coding

The **V320i** prints large area, high resolution codes, text and images on flexible foils, films and labels.

Domino's innovative **i-Tech** Ribbon Drive ensures the fastest printing speeds, allowing us to match or even exceed speeds of the fastest horizontal and vertical packaging machines, labellers and label converters.

With the largest ribbon rolls in the industry and unique ribbon save features, the **V320i** also delivers the lowest cost of ownership of all thermal transfer printers.

The **V320i** is also fully flexible, allowing you to choose whether you want to run in intermittent or continuous mode, left or right handed. It also lets you use your own user interface without the need for a dedicated controller.



A diverse range of applications



Large area printing of variable data onto papers, films and labels



Print variable product information (e.g. ingredients lists) onto generic packaging. Easily highlight specific text in compliance with European food labelling regulations



Print crisp clean text, logos and machine readable codes at the fastest speeds



Reliable printing in cold environments and excellent code adhesion – even after freezing



Greener credentials

Domino is committed to sound environmental practices and minimising the consumption of natural resources and energy and the creation of waste. We invest in our supply chain to ensure good social and environmental practice and we are supportive of developments to improve corporate accountability. Wherever practical, our products are RoHS and WEEE compliant.

Fastest printing speeds in the industry

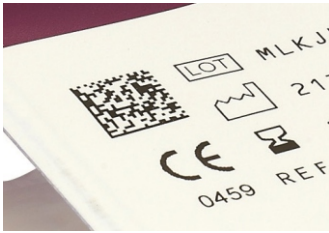

Accurate

The **V320i** prints complex data incredibly clearly and consistently across the full operating range – with an impressive speed range (from 10 to 1400mm/sec) and a high print repeat rate (up to six prints per second).

Clever

Domino's ground-breaking **i-Tech** Ribbon Drive incorporates our unique 'Dancing Arm' tension control. This keeps the ribbon in perfect tension even when under high acceleration, enabling you to print at the highest production speeds.

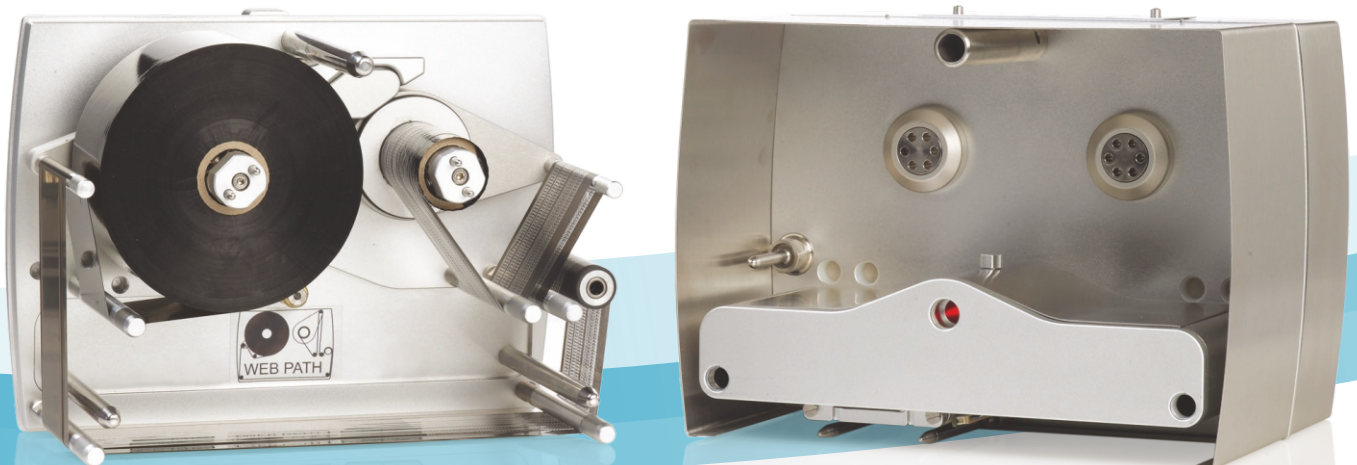

Easy to configure to match your application

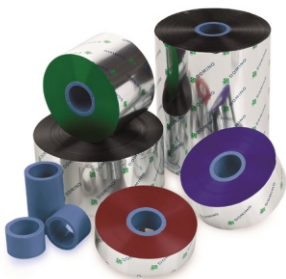

Versatile

Designed to be fully-flexible, the **V320i** serves the widest range of applications. You can use the same printer in both Intermittent Mode (IM) and Continuous Mode (CM) over the complete print speed range, and also easily convert between left- and right-handed positioning.

A full range of ribbons is available, complying with the latest legislative and environmental standards.

You can also use the **V320i** without a dedicated controller: Just connect to any PC based interface, including laptop or host packaging machine interface, to meet the needs of your application.

Capable

At 300dpi, the **V320i** tackles text, logos, dynamic bar codes and 2D codes with ease and can link seamlessly with a database if necessary. Two print head width options (53mm and 128mm) offer the widest range of print areas.

Resilient

The **V320i** performs just as well in conventional, dusty, damp or cold environments thanks to the removable cover, which protects the print head against dust and condensation. The integrated heater ensures consistent code quality and improves print head life at low temperatures.

Lowest Total Cost of Ownership in the industry

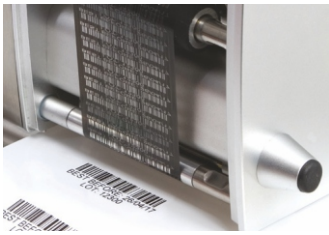

Economical

Domino's **i-Tech** Ribbon Drive offers 4 ribbon save settings including 'Economy Mode' which allows you to use up to 60% less ribbon per print – without affecting print quality: a major saving in ribbon costs.

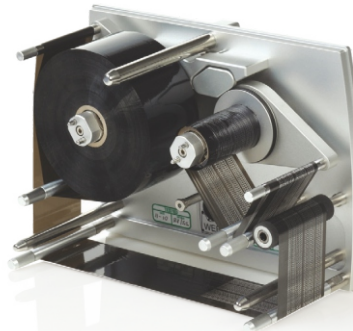

Efficient

1600m long ribbon rolls minimise the number of roll changes and downtime, and with Economy Mode, the effective length can more than double, halving the number of stoppages. During ribbon change, re-calibration is fast to get you printing again as quickly as possible.

Reliable and low maintenance

Ribbon breaks (and associated downtime) are virtually eliminated by **i-Tech's** unique 'Dancing Arms', which constantly maintain ribbon tension. They are also maintenance free so minimising any user intervention required.

Easy to use

QuickStep User Interface - no action is more than 3 taps away

QuickStep is our unique, simplified operator interface that gets the printer in action as quickly as possible. No complex menus or parameters, just enter the job and away you go.

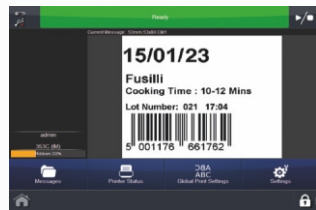

- Large user friendly icons and customisable home screen for quick access to favourite menus and settings
- Create and edit messages easily using the WYSIWYG drag and drop message editor at the line side
- Intuitive 3-tier menu structure makes **QuickStep** quick to learn and simple to remember
- Simplified Message Store and live WYSIWYG message preview to speed up changeovers and help eliminate coding selection errors

QuickDesign Lite - Simplifying message design

QuickDesign Lite is a single, easy to use Windows® application that gives you the flexibility of creating all types of coding messages from a remote PC. It also lays the foundation for providing increased automation of your coding needs.

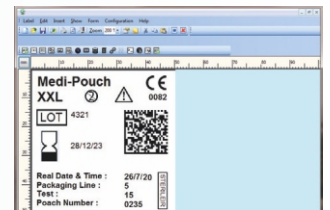

- Simply create, edit and send your message to your **V320i** by network or USB stick
- Allows simple highlighting of text in compliance with European food labelling regulations.
- Available for your **V320i** at no extra cost
- Easily upgradeable to **QuickDesign** for increase connectivity, control and Coding Automation capabilities

Domino. Do more.

Technical Specification:

	V320i (53mm)	V320i (128mm)
Printer Specification		
Printing Modes	Intermittent Mode (IM) and Continuous Mode (CM) in the same printer	
Left hand / Right hand	Both options available	
Print resolution	300 dpi	
Maximum print area (IM)	53mm x 115mm	128mm x 115mm
Maximum print area (CM)	53mm x 2700mm	128mm x 1000mm
Print speed (max) (IM)	720mm/*	
Speed range (CM)	10mm/s – 1400 mm/s*	
Print repeat rate (max)	6 prints/s (with a 10mm long print)*	
Ribbon drive technology	i-Tech Ribbon Drive with unique Dancing Arm tension control	
Max ribbon length	1600m (up to 4000m effective length with Economy Mode)	
Standard Ribbon widths	30mm, 55mm	130mm
Ribbon save modes		
Economy mode	Variable in 1% increments up to 60%	
Retraction mode	Less than 1mm gap between prints	
Column mode	Yes	
Stop mid print	Yes	
Print features		
Date code format	Yes	
Offsets	Yes	
Shift codes	Yes	
Serial number generation	Yes	
Fonts	Yes	
Dynamic bar codes	Yes	
2D codes	Yes	
Database linking	Yes	
Graphical User Interface	QuickStep , full colour Interface Intuitive navigation via large, easy to read buttons and icons. WYSIWYG print preview. Multi-language support	
Controller options	No dedicated controller required. Hardware Interface options: <ul style="list-style-type: none"> • Domino TouchPanel via Ethernet cable or network • Domino TouchPad via Ethernet cable or network • PC based interface via Ethernet cable or network 	
Connectivity	Ethernet, USB, SD card and Mini USB (for service)	
Inputs	Print Go, Encoder	
Outputs	Error, Ready (software configurable)	
Special features	Master slave, password, fastmode, macros, Labelspeed	
Label creation	Onboard and via QuickDesign (included)	
Electrical requirements	115/240 VAC, 50/60 Hz, 300 VA	
Compressed air requirements	0.3ml / Print (6 Bar Max) 0.5ml / Print (6 Bar Max)	
Dimensions	W 262mm x H 190.3mm x D 220mm	W 262mm x H 190.3mm x D 295mm
Weight	12kg	13.5kg
TouchPanel Specification		
Type	10.4 inch, full colour touchscreen (800x600 resolution) VESA mountable with optional brackets	
I.P. Protection	Certified to IP65	
Connectivity	2 x USB, Ethernet	
Electrical requirements	100/240 VAC, 50/60 Hz	
Dimensions	W 307mm x H 232mm x D 75mm	
Weight	2.8kg	
TouchPad Specification (not illustrated)		
Type	5.7 inch, full colour touchscreen (640x480 resolution) Handheld with docking station included	
Connectivity	Ethernet (for connection to printer or Network), USB	
Electrical requirements	Powered via universal Mini USB power adapter (supplied) 115/240 VAC, 50/60Hz input	
Dimensions	W 170.0mm x H 127.9mm x D 33.7mm (excluding docking station)	
Weight	0.4kg	
PSU Specification		
Dimensions	W 171.6mm x H 84.6mm x D 273.9mm	
Weight	2.45kg	
Environmental requirements	Temperature: 5°C to 40°C. Humidity: 20-80%, non condensing	

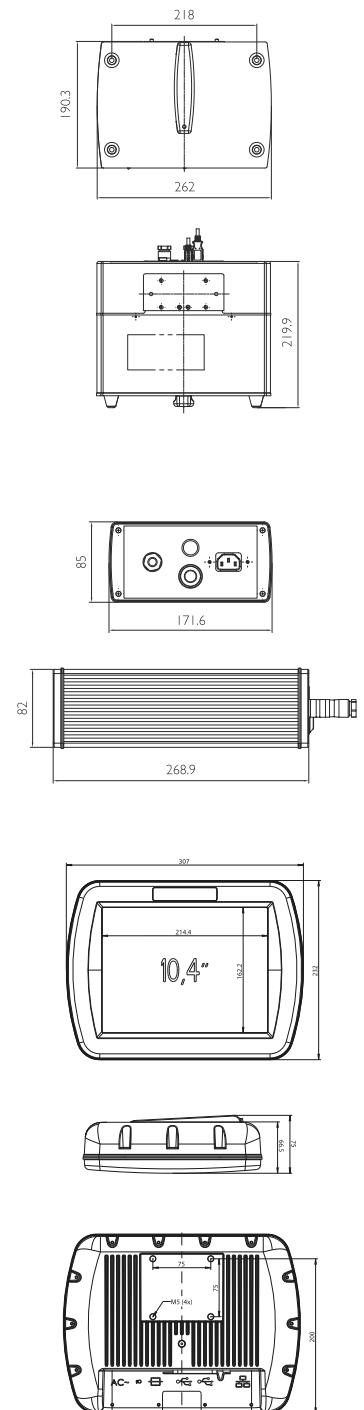

*Note: Print capability is dependent upon application and substrate type.



CONTACT US

TALK TO AN EXPERT

+91-900 900 6612
enquiry@dominoindia.com
www.domino-printing.com



KNOW MORE